

---

**HP 8719C  
HP 8720C  
HP 8722C  
Network Analyzer**

**Technical Data**

**50 MHz to 13.5 GHz  
50 MHz to 20 GHz  
50 MHz to 40 GHz**

---

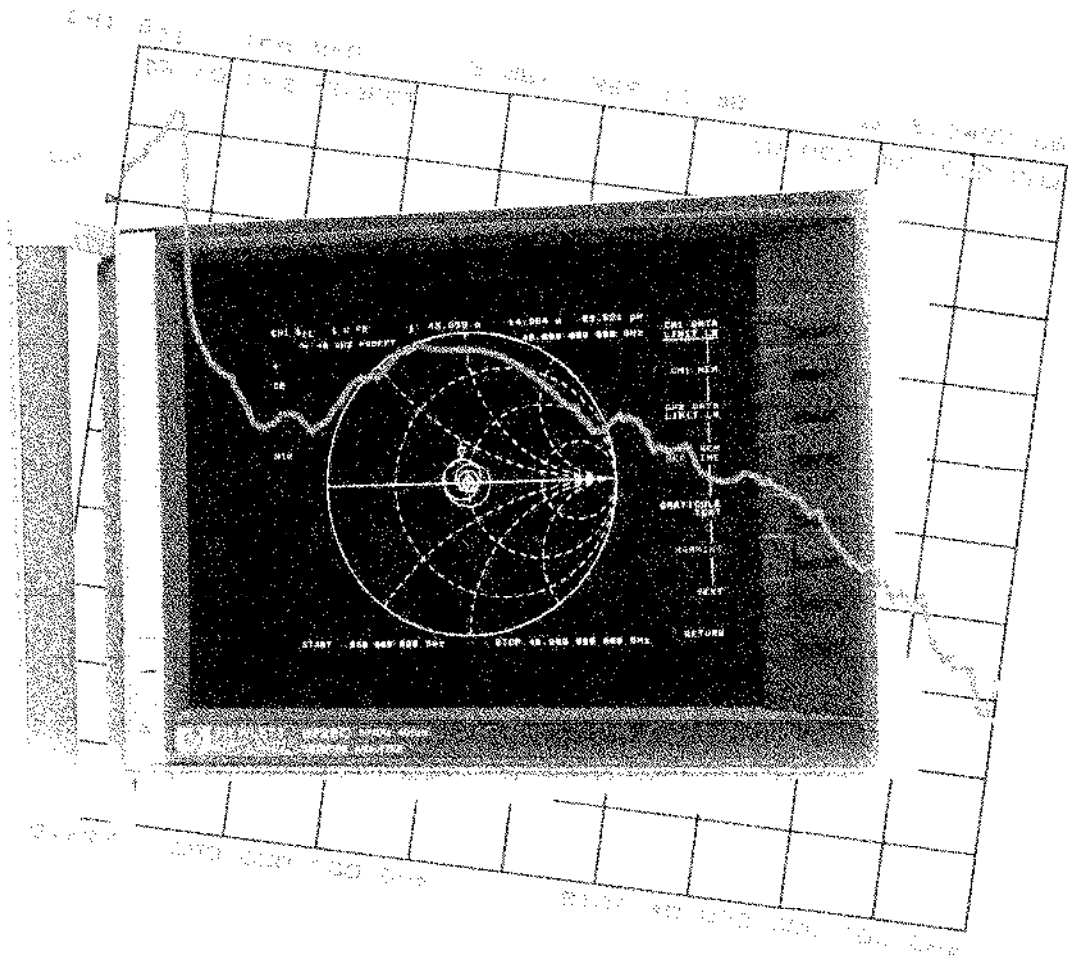

# System performance

HP 8719C, 50 MHz to 13.5 GHz

HP 8720C, 50 MHz to 20 GHz

with 3.5mm test ports

Cal kit: HP 85052B 3.5 mm with sliding loads

Cables: HP 85131F 3.5 mm flexible cable set

IF bandwidth: 10 Hz

Averaging: none (except during isolation cal)

## Dynamic range

	Frequency range			
	.05-.5	.5-2	2-8	8-20
Maximum receiver power (<0.1 dB compression)	+20 dBm	+13 dBm	+10 dBm	+10 dBm
Maximum source power (at test ports)	+10 dBm	+10 dBm	+10 dBm	+10 dBm
Receiver noise floor (sensitivity)	-65 dBm	-90 dBm	-93 dBm	-93 dBm
Receiver dynamic range	85 dB	103 dB	103 dB	103 dB
System dynamic range	75 dB	100 dB	103 dB	103 dB

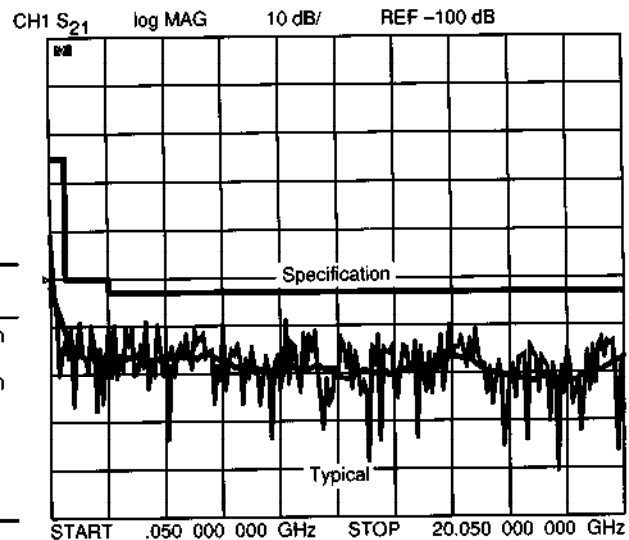

## Measurement uncertainty

### Reflection measurements

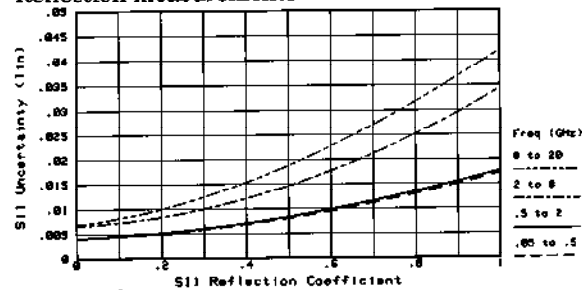

### Magnitude

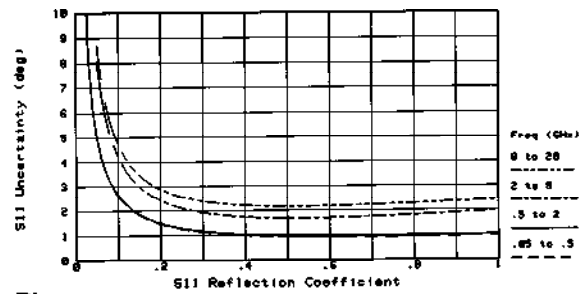

### Phase

### Transmission measurements

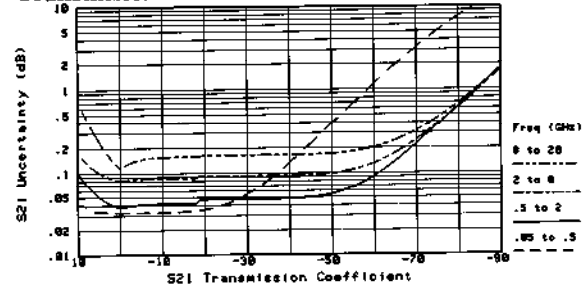

### Magnitude

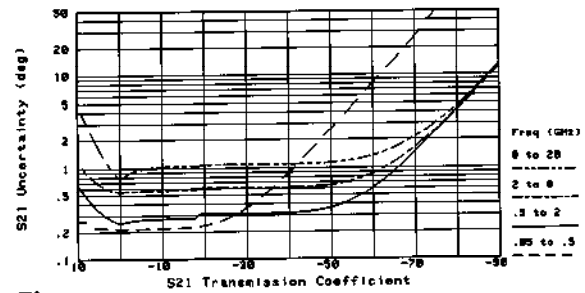

### Phase

## Measurement port characteristics

	Frequency range (GHz)			
	.05-.5	.5-2	2-8	8-20
Residual				
Directivity	48 dB	48 dB	44 dB	44 dB
Source match	40 dB	39 dB	32 dB	30 dB
Load match	48 dB	45 dB	38 dB	37 dB
Reflection tracking	0.006 dB	0.010 dB	0.031 dB	0.031 dB
Transmission tracking	0.009 dB	0.016 dB	0.065 dB	0.106 dB

	Frequency range (GHz)			
	.05-.5	.5-2	2-8	8-20
Raw (typical)				
Directivity	32 dB	32 dB	26 dB	18 dB
Source match	20 dB	18 dB	14 dB	11 dB
Load match	26 dB	24 dB	15 dB	12 dB

# System performance

Option 006 (HP 8719C, 8720C)

**Description:** Option 006 replaces the mechanical test port switch with a solid-state transfer switch that operates in a continuous switching mode.

Cal kit: HP 85052B 3.5 mm with sliding loads  
 Cables: HP 85131F 3.5 mm flexible cable set  
 IF bandwidth: 10 Hz  
 Averaging: none (except during isolation cal)

## Dynamic range

	Frequency range			
	.05-.5	.5-2	2-8	8-20
Maximum receiver power (<0.1 dB compression)	+20 dBm	+13 dBm	+10 dBm	+10 dBm
Maximum source power (at test ports)	+5 dBm	+5 dBm	+5 dBm	+5 dBm
Receiver noise floor (sensitivity)	-65 dBm	-90 dBm	-93 dBm	-93 dBm
Receiver dynamic range	85 dB	103 dB	103 dB	103 dB
System dynamic range	70 dB	95 dB	98 dB	98 dB

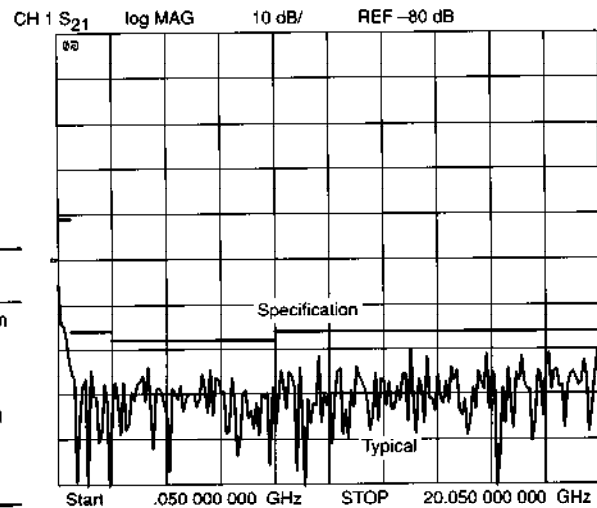

## Measurement uncertainty

### Reflection measurements

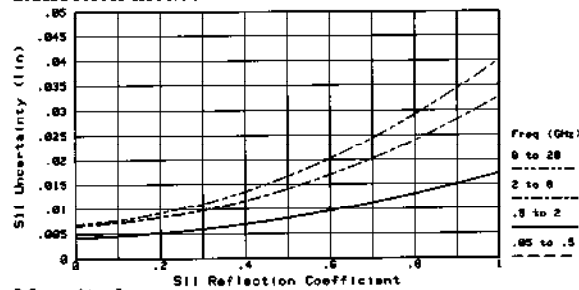

Magnitude

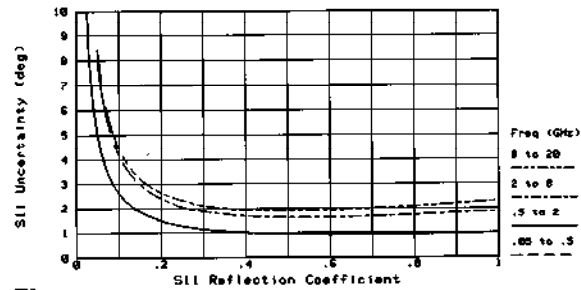

Phase

### Transmission measurements

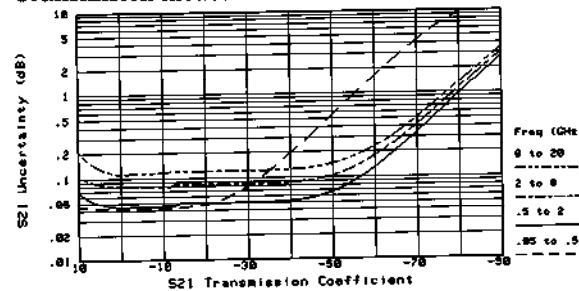

Magnitude

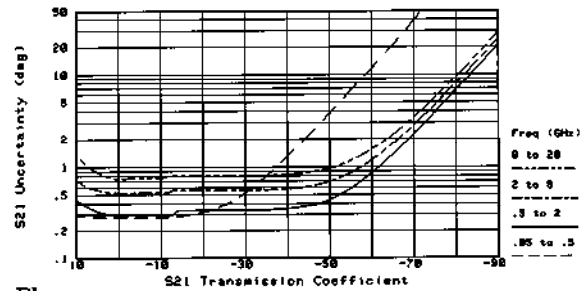

Phase

## Measurement port characteristics

Residual	Frequency range (GHz)			
	.05-.5	.5-2	2-8	8-20
Directivity	48 dB	48 dB	44 dB	44 dB
Source match	40 dB	40 dB	33 dB	31 dB
Load match	48 dB	48 dB	44 dB	44 dB
Reflection tracking	0.006 dB	0.006 dB	0.006 dB	0.008 dB
Transmission tracking	0.019 dB	0.021 dB	0.052 dB	0.079 dB

Raw (typical)	Frequency range (GHz)			
	.05-.5	.5-2	2-8	8-20
Directivity	32 dB	32 dB	26 dB	18 dB
Source match	10 dB	10 dB	10 dB	10 dB
Load match	22 dB	20 dB	15 dB	12 dB

# System performance

HP 8722C, 50 MHz to 40 GHz  
with 2.4mm test ports

Cal kit: HP 85056A 2.4mm with sliding loads

Cables: HP 85133F 2.4mm flexible cable set

IF bandwidth: 10 Hz

Averaging: none (except during isolation cal)

## Dynamic range

	Frequency range			
	.05-2	2-8	8-20	20-40
<b>Maximum receiver power</b> ( $<0.1$ dB compression)	+12 dBm	+8 dBm	+8 dBm	+4 dBm
<b>Maximum source power</b> (at test ports)	0 dBm	0 dBm	0 dBm <sup>1</sup>	-5 dBm
<b>Receiver noise floor</b> (sensitivity)				
Standard	-98 dBm	-98 dBm	-93 dB	-92 dBm
Option 003	-107 dBm	-107 dBm	-102 dB	-101 dBm
<b>Receiver dynamic range</b>	110 dB	106 dB	101 dB	96 dB
<b>System dynamic range</b>				
Standard	98 dB <sup>2</sup>	98 dB	93 dB <sup>1</sup>	87 dB
Option 003	107 dB	107 dB	102 dB <sup>1</sup>	96 dB

<sup>1</sup> Valid to 26.5 GHz

<sup>2</sup> Rolls off below 840 MHz to 76 dB at 50 MHz

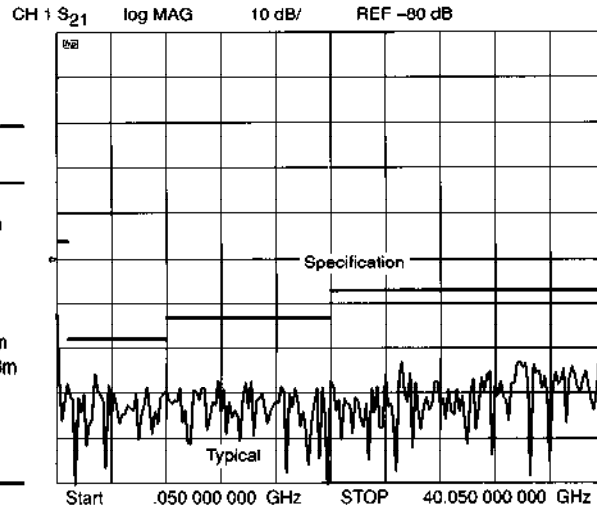

## Measurement uncertainty

### Reflection measurements

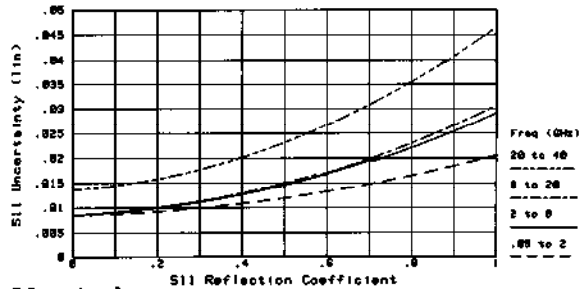

### Magnitude

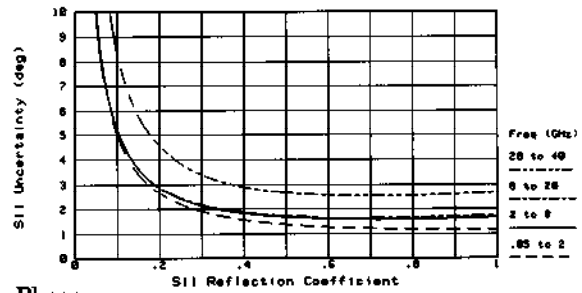

### Phase

### Transmission measurements

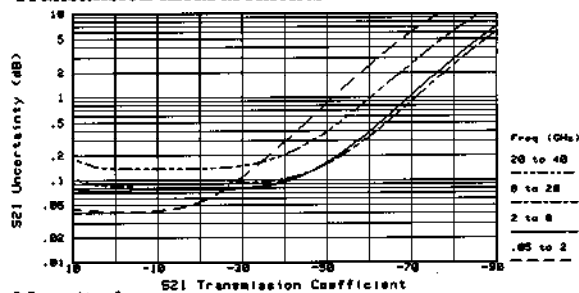

### Magnitude

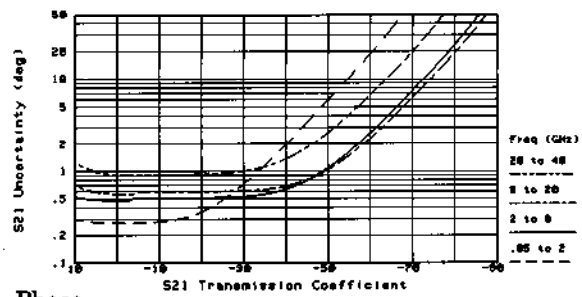

### Phase

## Measurement port characteristics

	Frequency range			
	.05-2	2-8	8-20	20-40
<b>Residual</b>				
Directivity	42 dB	42 dB	42 dB	38 dB
Source match	40 dB	35 dB	34 dB	31 dB
Load match	41 dB	38 dB	37 dB	35 dB
Reflection tracking	0.011 dB	0.037 dB	0.039 dB	0.047 dB
Transmission tracking	0.017 dB	0.052 dB	0.075 dB	0.130 dB

	Frequency range (GHz)			
	.05-2	2-8	8-20	20-40
<b>Raw (typical)</b>				
Directivity	20 dB	20 dB	20 dB	20 dB
Source match	20 dB	15 dB	12 dB	8 dB
Load match	23 dB	18 dB	14 dB	12 dB

# System performance (typical)

HP 8722C, 50 MHz to 40 GHz  
with 2.92mm (K-connector) test ports

Cal kit: HP 85056K Option 001 2.4mm with sliding loads (apply 2.92mm adapters from HP 85056K or 11904S after 2.4mm calibration)  
Cables: HP 85133F 2.4mm flexible cable set  
IF bandwidth: 10 Hz  
Averaging: none (except during isolation cal)

## Dynamic range

Same as HP 8722C with 2.4mm connectors.

## Measurement uncertainty

### Reflection measurements

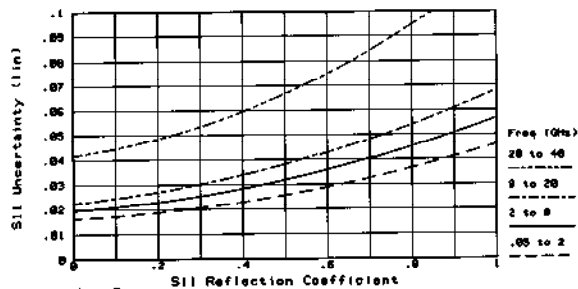

Magnitude

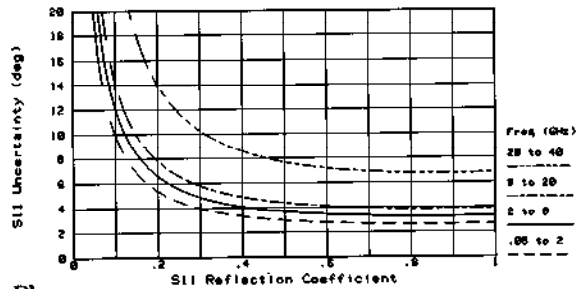

Phase

### Transmission measurements

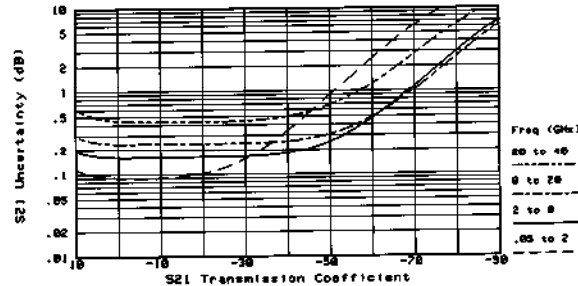

Magnitude

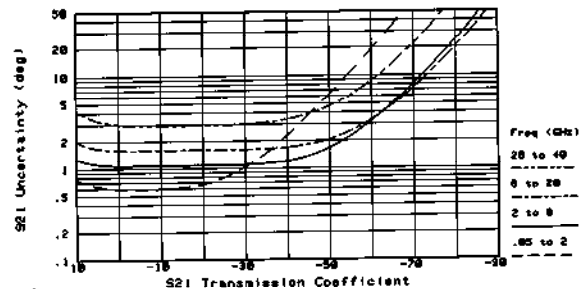

Phase

Note: System performance in 2.92mm (K) connectors is provided to indicate typical uncertainty using 2.92mm adapters after 2.4mm calibration. Performance is not verifiable due to lack of traceable standards in K-connectors. These curves indicate worst-case sums of errors; typical uncertainties are less than half the values indicated.

# System performance

## Option 011 (HP 8719C, 8720C, 8722C)

**Description:** Option 011 allows direct access to the R, A, and B samplers and receivers. The user may measure A, B, R, A/R, B/R, or A/B; only ratios are valid for phase measurements. The transfer switch, couplers, and bias tees are removed. External accessories are therefore required to make most measurements.

**Phase locking:** a sample of the source output between -10 and -33 dBm must be provided to the R input for phase-locking. This may come directly from the R output provided, or from an external coupler or splitter in the source output chain.

**Bias:** no DC bias may be applied to any input, so external DC blocks (or bias tees) must be added if center conductors carry a bias voltage.

Low level noise defined as mean of receiver noise (signal/noise ratio of unity) with ports terminated by 50 ohms. Levels are adjusted for typical sampler conversion gain, as if a response calibration to a known power level had been established.

Noise floor is statistically defined as a level over  $3\sigma$  (standard deviations) above mean of the noise trace. A signal at this level has a signal/noise ratio of at least 10 dB. There is a high probability that noise "peaks" are below the noise floor.

**Source output characteristics:** same as standard product

**High level noise:** same as standard product

**Connectors:** 3.5mm (f) for HP 8719C and 8720C; 2.4mm (f) for HP 8722C

### Summary of capabilities

	Frequency range			
	.05-2	2-6	6-20	20-40
Maximum input (<0.1 dB compression)	-4 dBm	-6 dBm	-10 dBm	-17 dBm
Low level noise (S/N=1)	-106 dBm	-102 dBm	-100 dBm	-90 dBm
Receiver dynamic range	112 dB	106 dB	100 dB	88 dBm
Port match	19 dB	17 dB	15 dB	11 dB
Tracking	$\pm 0.4$ dB	$\pm 0.8$ dB	$\pm 1.0$ dB	$\pm 3.0$ dB

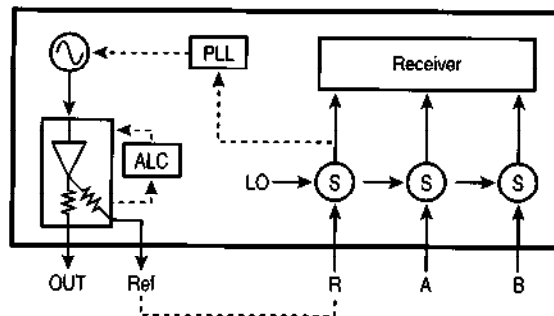

### Dynamic Accuracy:

The following plots illustrate worst case magnitude and phase uncertainty due to IF residuals and detector inaccuracies. Excludes uncertainty due to frequency response, isolation, port match and connector repeatability.

A, B channel measurements<sup>1</sup>

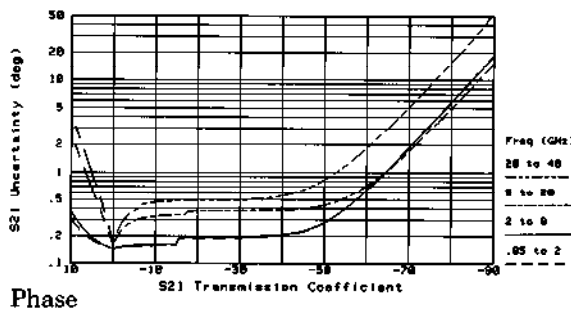
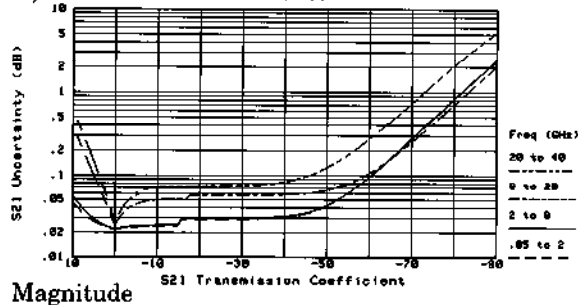

<sup>1</sup> Reference power level is -5 dBm into the test port.

# Capabilities

- ↻ Indicates new capabilities over HP 8719A and 8720B
- ⇒ Indicates new capabilities and changes from the HP 8722A

## Measurement

**Number of channels:** 2; each fully independent

### Parameters:

- S11: Forward reflection (input match)
- S21: Forward transmission (insertion loss/gain/phase)
- S12: Reverse transmission (reverse isolation)
- S22: Reverse reflection (output match)
- AUXILIARY INPUT: DC voltage on AUX INPUT
- A, B, R, A/R, B/R, A/B (for Option 011)

Parameter conversion: 1-term

- Z - Reflection: equivalent parallel impedance
- Y - Reflection: equivalent parallel input/output admittance
- Z - Transmission: equivalent series impedance
- Y - Transmission: equivalent series admittance
- 1/S: complex inverse of S-parameters

### Display formats:

**Reflection:** linear magnitude (reflection coefficient, rho); log magnitude (return loss or match in dB); SWR or VSWR (voltage standing wave ratio); phase; polar (complex reflection coefficient, Γ); Smith chart (complex impedance); inverse Smith chart (complex admittance)

**Transmission:** linear magnitude (transmission coefficient, τ); log magnitude (insertion loss/gain in dB, power in dBm); phase (insertion phase, deviation from linear phase, electrical length); group delay (transit time, τ<sub>g</sub>, -Δφ/360\*Δf); polar (complex transmission coefficient)

**Tabular display formats:** lists numeric values, one line per stimulus point; up to 5 columns of data (depending on format, dual-channel, and limit test status): stimulus, data (using current format) and margin (difference between data and nearest limit line) for each channel, and PASS/FAIL indicator; 30 points per screen

**Instrument modes:** network analyzer (normal); tuned receiver (receiver is set to a fixed frequency to downconvert signal from an external synthesized source with time-base locked to HP 8720)

### High-level trace noise (typical):

IF bandwidth	Magnitude (dB zero-peak)	Phase (deg zero-peak)
3000	0.1	0.6
1000	0.04	0.25
300	0.015	0.08
100	0.006	0.04
30	0.004	0.02
10	0.003	0.015

**Phase resolution (typical):** 0.3 deg (for input of constant amplitude)

**Group delay:** computed by from the phase change over a frequency interval

$$\text{Group Delay} = \frac{-\Delta \phi}{360^\circ \times \Delta f}$$

**Range:** limited to 5 μs standard or 500 ms with Option 001  
Range = 1/(2 \* Aperture<sub>min</sub>)

**Aperture:** variable frequency interval over which group delay is computed; small apertures show response details but may be noisy; large apertures yield less noise but “smooth” details

$$\text{Aperture}_{\min} = \frac{F_{\text{span}}}{(\text{number-of-points} - 1)}$$

(limited to 100 kHz standard or 1 Hz with Option 001)

$$\text{Aperture}_{\max} = 20\% \text{ of } F_{\text{span}}$$

(limited such that Δφ < 180°)

**Accuracy:** function of uncertainty in determining phase change; typically

$$\text{Delay Uncertainty} = \frac{\pm 0.003 \text{ (Phase Uncertainty in deg)}}{\text{Aperture in Hz}}$$

## Markers

**Number of markers:** 5 per channel; 1 “active” per channel; can be coupled (same stimulus in both channels) or uncoupled (independent stimulus in each channel)

**Displayed marker values:** all activated markers with both stimulus and response values are displayed on CRT; with dual-channel uncoupled, can display up to 10 markers; all but active marker replaced by bandwidths or statistics, when enabled

**Stimulus resolution:** discrete (actual measurement points) or continuous (linearly interpolated between points, with 100 kHz resolution standard or 1 Hz with Option 001)

**Delta markers:** displays difference in both stimulus (e.g. frequency) and response (e.g. dB) between active marker and reference marker; reference marker may be any of five markers, or a sixth fixed marker given any arbitrary position on display

**Polar format markers:** linear magnitude and phase; log magnitude (dB) and phase; real and imaginary Smith chart format markers: Linear magnitude and phase; log magnitude (dB) and phase; real and imaginary (R+jI); complex impedance (R+jX); complex admittance (G+jB)

**Search:** finds maximum, minimum, or target value

↻ **Bandwidth:** finds and displays center frequency, bandwidth at a user-defined level (e.g. -3 dB), Q factor, and shape factor (ratio of 60 dB and 6 dB bandwidths); updates while tuning with tracking enabled; valid for band-pass or band-reject (notch) filters

**Statistics:** calculates and displays mean, standard deviation, and peak-to-peak deviation of trace; active between two markers or over entire trace

**Tracking:** performs new search (min/max/target) at end of each sweep; if disabled, occurs once on demand

**Marker-To Functions:** active marker stimulus to start, stop, or center; active and delta marker to stimulus span; active marker response to reference value; active marker to delay (sets electrical delay to remove linear portion of phase response)

## Source frequency characteristics

### Range

	HP 8719C	HP8720C	HP 8722C
Minimum frequency	50 MHz	50 MHz	50 MHz
Maximum frequency	13.51 GHz	20.05 GHz	40.05 GHz

**Frequency resolution:** 100 kHz (standard); 1 Hz with Option 001; accuracy and stability not affected by Option 001; see table below

	Standard	Option 001
Source resolution (start, stop, center, span)	100 kHz	1 Hz
Marker resolution	100 kHz	1 Hz
Minimum span at 101 points	10 MHz	100 Hz
Minimum span at 201 points	20 MHz	200 Hz
Maximum time domain range	10 $\mu$ s	1 s
Maximum group delay range	5 $\mu$ s	500 ms
Minimum group delay aperture	100 kHz	1 Hz

**Frequency accuracy:** 10 ppm at 23°  $\pm$  3°C (can be locked to external frequency reference)

### Frequency stability (typical):

$\pm$ 7.5 ppm over 0° to 55°C (temperature)  
 $\pm$ 3 ppm per year (aging)

**Control:** set start/stop or center/span

**Number of points:** 3, 11, 21, 51, 101, 201, 401, 801, 1601

### Sweep types:

*Linear*

*Log* (not valid for less than 4:1 bandwidth)

*Arbitrary frequency list:* define up to 30 different subsweep frequency segments; in any combination of CW, start/stop, or center/span modes; arbitrary number of points up to 1601 points total; overlapping or nested subsweeps allowed  
*CW time:* fixed source frequency, with time as horizontal axis

Power sweep: sweep power level, at a CW frequency

**Source coupling:** coupled (same frequency range in both channels) or uncoupled (independent for each channel, for "alternate sweep" mode)

**Sweep time:** manual or automatic (uses fastest possible sweep time for given frequency range, number of points, etc)

**Sweep trigger:** continuous, hold, single sweep, group (1 to 999 sweep sets), external trigger of entire sweep

Single point trigger: external or manual (button) trigger to acquire single point of multi-point sweep; compatible with any sweep type

### Sweep modes:

*Synthesized sweep:* smooth linear sweep ramp (in each band); frequency fully and continuously synthesized at all times; data acquired "on the fly"

*Synthesized step:* frequency is fixed while acquiring data, then ramps to next point; dwell time adjustable via manual sweep time; user-selectable, or automatically activated by sweep time of >15 ms per point, list frequency mode, or bandwidth of 10 or 30 Hz

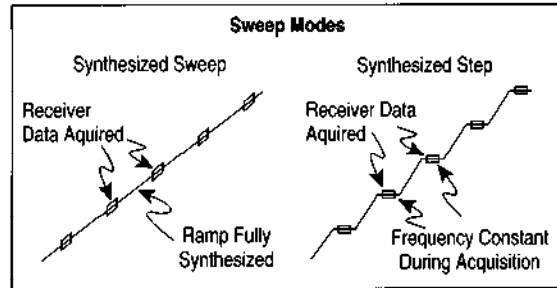

### Spectral purity (typical):

*Harmonics:* <-15 dBc at +10 dBm

*Phase noise:* <-35 dBc to 60 kHz from carrier

*Spurs:* <-40 dBc at 100 kHz

<-50 dBc at 200 kHz

<-65 dBc at >200 kHz

## Source power characteristics

### Power range:

	HP 8719C	HP8720C	HP 8722C
Maximum power (below 26.5 GHz)	+10 dBm <sup>1</sup>	+10 dBm <sup>1</sup>	-5 dBm <sup>2</sup>
Minimum power	-65 dBm <sup>1</sup>	-65 dBm <sup>1</sup>	-60 dBm
Resolution	0.05 dB	0.05 dB	0.05 dB
Flatness	$\pm$ 2 dB	$\pm$ 2 dB	$\pm$ 3 dB

<sup>1</sup> For Option 006, lower power values by 5 dB.

<sup>2</sup> For Option 003, lower port 2 power by approximately 15 dB coupler roll-off.

### Power sweep: continuous in ranges staggered by 5 dB

	HP 8719C	HP8720C	HP 8722C
Range	20 dB	20 dB	15 dB
Linearity	$\pm$ 0.5 dB	$\pm$ 0.5 dB	$\pm$ 0.5 dB
Linearity (<5 dB sweep)	$\pm$ 0.2 dB	$\pm$ 0.2 dB	$\pm$ 0.2 dB

**Power accuracy:**  $\pm$ 0.5 dB at 50 MHz at maximum power

**Power meter calibration:** improves output power accuracy and flatness, referenced to HP 437B or 438A power meter; network analyzer controls power meter directly during calibration sweep, then corrects power level at fast sweep rate

**Test ports:** NMD-3.5mm male (ruggedized) for HP 8719C and 8720C; NMD-2.4mm male (ruggedized) for HP 8722C; not included in Option 011; 50 ohm nominal impedance